

DIMENSIONI TECNICHE

TECHNICAL DIMENSIONS | DIMENSIONES TÉCNICAS | DIMENSIONS TECHNIQUES | ТЕХНИЧЕСКИЕ РАЗМЕРЫ

BASI SOSPESE

HANGING BASES
 MUEBLES BAJOS SUSPENDIDOS
 ELÉMENTS BAS SUSPENDUS
 НАВЕСНЫЕ НИЖНИЕ ТУМБЫ

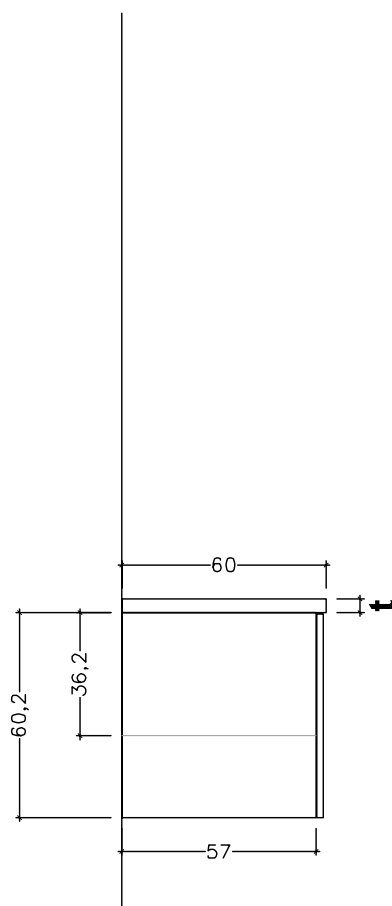

BASI / PENSILI

BASES / WALL UNITS
 MUEBLES BAJOS / MUEBLES ALTOS
 ELÉMENTS BAS / ELÉMENTS HAUTS
 НАВЕСНЫЕ ВЕРХНИЕ ШКАФЫ

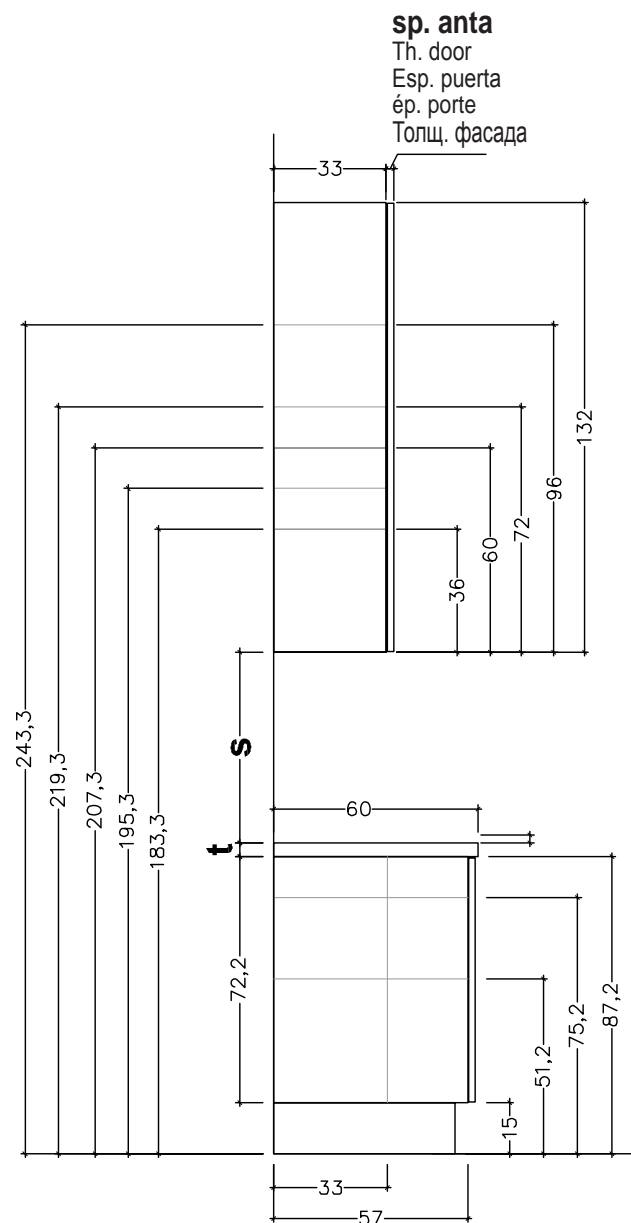

COLONNE

VERTICAL UNITS
 COLUMNAS
 COLONNES
 ШКАФЫ-ПЕНАЛЫ

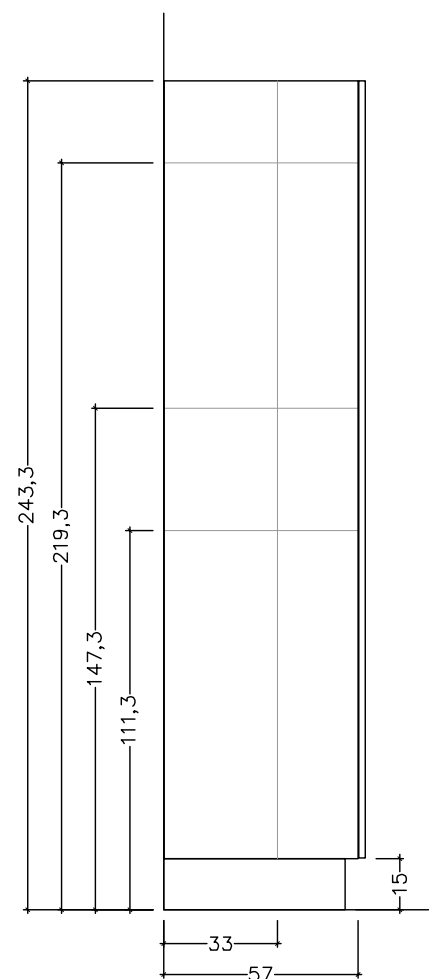

t = (cm)	s = (cm)
2	58.1
3	57.1
4	56.1
6	54.1
10	50.1

t = la misura della piana varia da cm 2 fino a cm 10

s = la misura varia in base all'altezza della piana

t = the size of the top surface varies from 2 cm to 10 cm

s = the size varies in accordance with the height of the top surface

t = la medida de la encimera varía entre 2 y 10 cm

s = la medida varía según la altura de la encimera

t = la mesure du plateau varie de 2 cm jusqu'à 10 cm

s = la mesure varie selon la hauteur du plateau

t = размер топа варьирует от 2 до 10 см

s = размер варьирует в зависимости от толщины топа

COMPONIBILITÀ MODULI A GIORNO

MODULARITY OF OPEN SHELVING MODULES | MODULARIDAD MÓDULOS ABIERTOS |
 POSSIBILITÉ D'AGENCEMENT DES MODULES OUVERTS | КОНФИГУРАЦИИ ОТКРЫТЫХ МОДУЛЕЙ

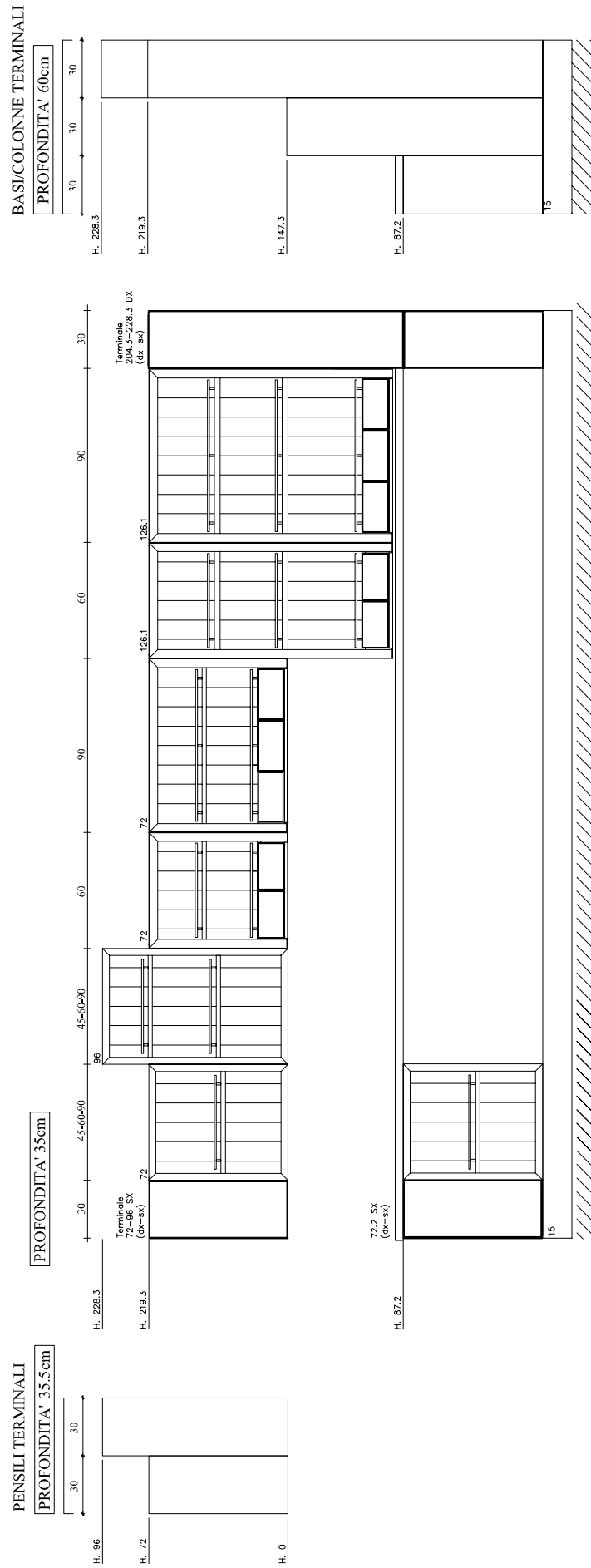

COMPONIBILITÀ PENSILI

MODULAR CABINETS | MODULARIDAD DE LOS MUEBLES ALTOS | POSSIBILITÈ D'AGENCEMENT D'ELEMENTS HAUTS | СОЧЕТАЕМОСТЬ НА ВЕСЬХ ШКАФОВ

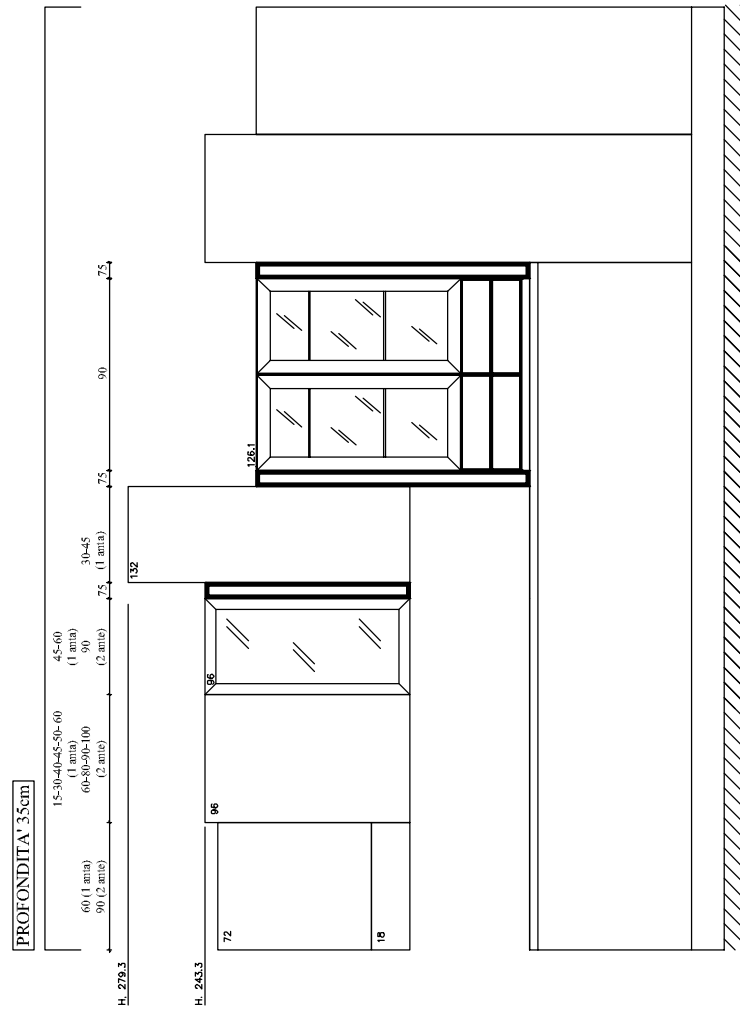
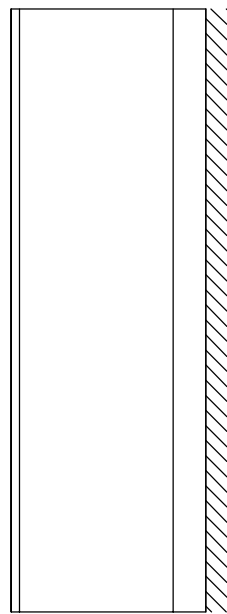
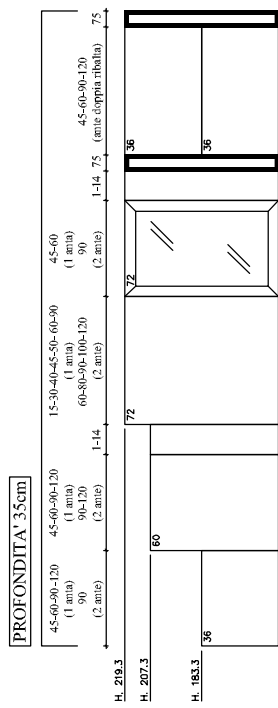

COMPONIBILITÀ BASI

MODULAR BASES | MODULARIDAD DE LOS MUEBLES BAJOS |

POSSIBILITÀ D'AGENCEMENT DE SELEMENTS BASI | СОЧЕТАЕМОСТЬ НА ПОЛНЫХ ШКАФОВ

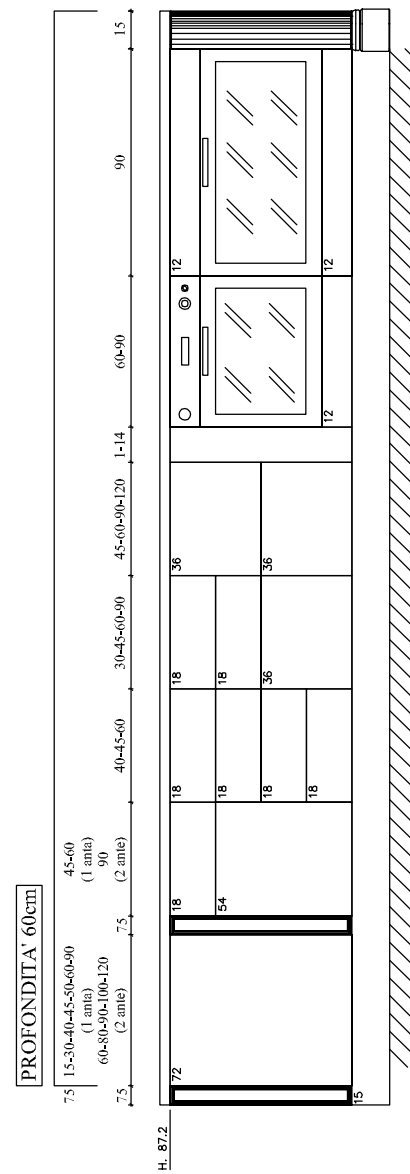
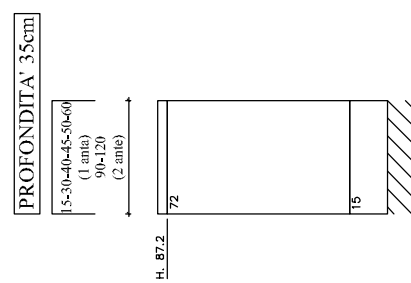
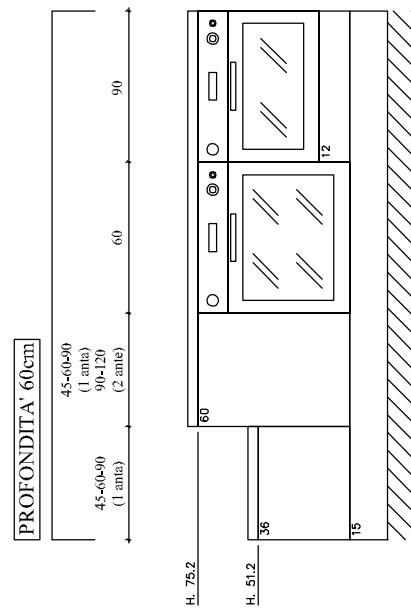
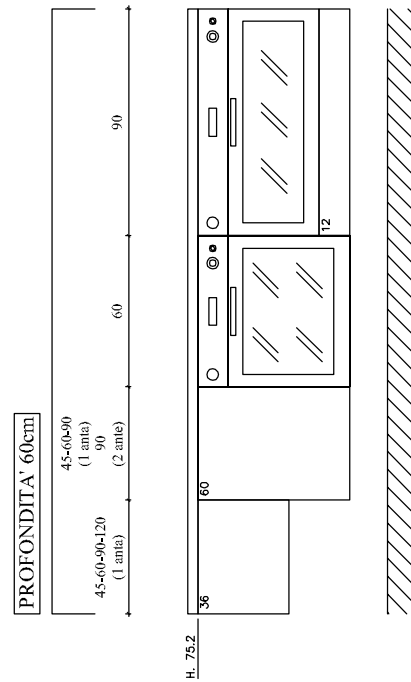

COMPONIBILITÀ COLONNE FORNO

MODULAR UPRIGHT OVEN UNITS | MODULARIDAD DE LAS COLUMNAS HORNO | POSSIBILITE D'AGENCEMENT DES COLONNES FOUR | СОЧЕТАЕМОСТЬ ШКАФОВ-ПЕНАЛОВ ПОД ДУХОВОЙ ШКАФ

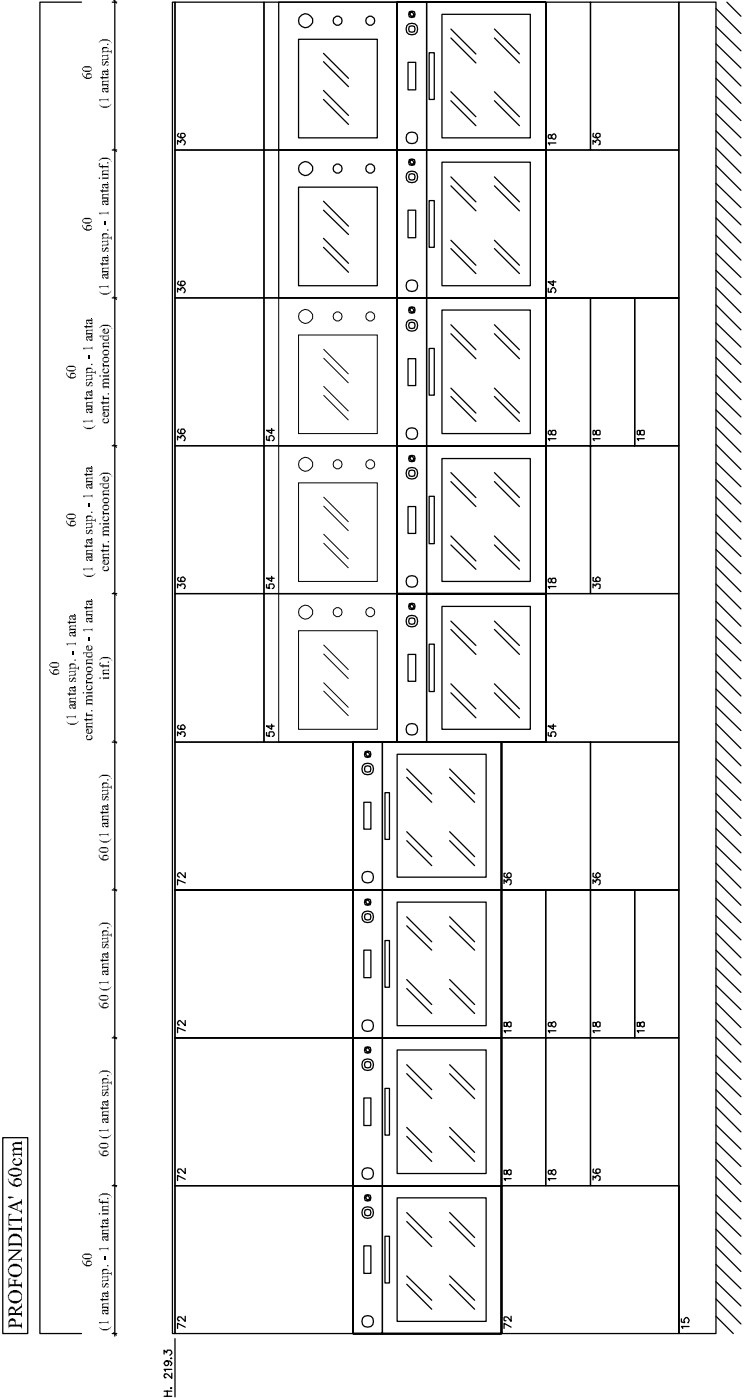
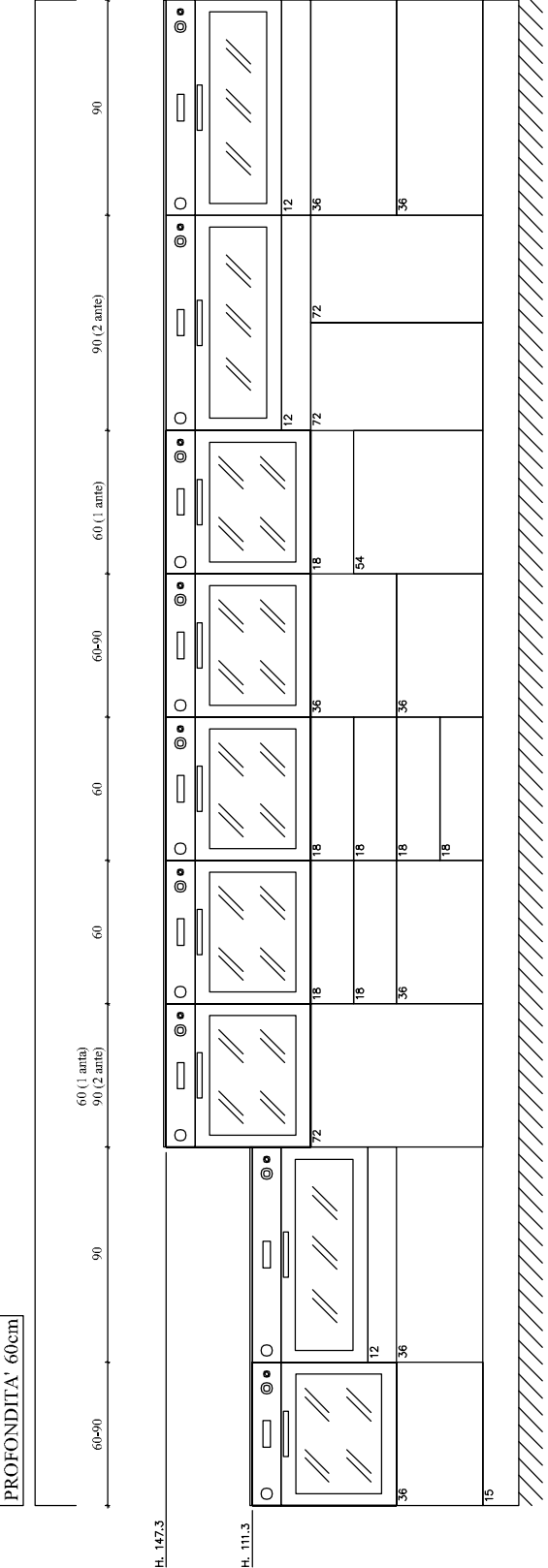

COMPONIBILITÀ COLONNE FORNO

MODULAR UPRIGHT OVEN UNITS | MODULARIDAD DE LAS COLUMNAS HORNO |

POSSIBILITE D'AGENCEMENT DES COLONNES FOUR |

СОЧЕТАЕМОСТЬ ШКАФОВ-ПЕЧАЛОВ ПОД ДУХОВОЙ ШКАФ

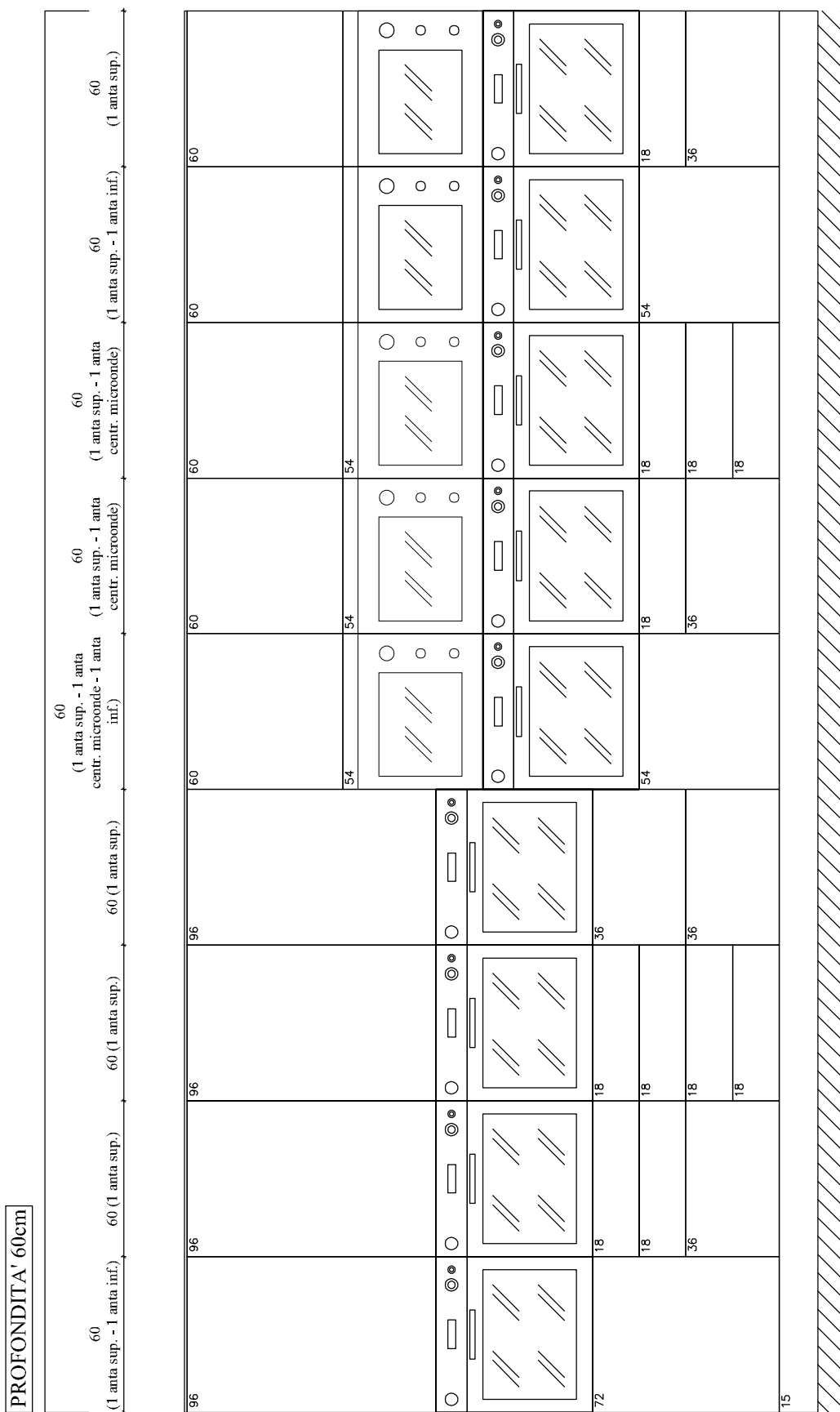

H. 243.3

COMPONIBILITÀ COLONNE

VERTICAL UNITS MODULARITY | COMPONENTES DE COLUMNAS | ÉLÉMENTS DES COLONNES | КОМПОНОВКА КОЛОНН

